

# Original

rev. 02-14.12.21

## Technical sheet

English

Download  
The guide  
at:  
[www.tartadesign.it](http://www.tartadesign.it)

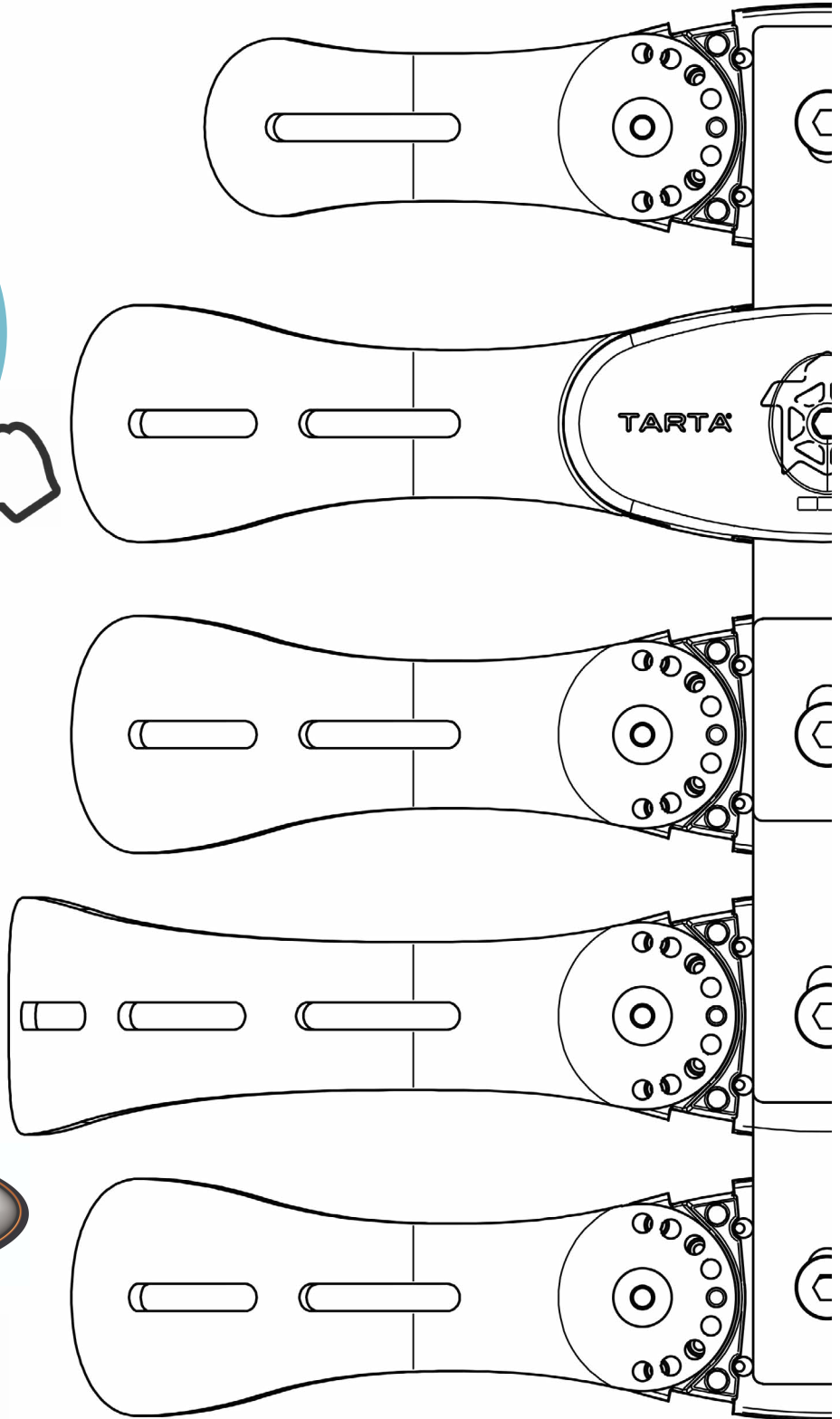

**TARTA**<sup>®</sup>  
RESHAPES LIFE



## Main features

### Customization

Designed to be adaptable to the user's needs, every single part of the Original can be customised to fit the individual with minimal tools and easy adjustments.

### Flexibility

Original® is the most flexible backrest in the world! The central column gives freedom of movement and support to improve quality of life for users.



### Comfort

Comfortable washable foam pads can be used in any combination and with 12 different shapes to choose from it is unique to the user's needs.

### Design

Original® is the winner of 5 International design contests. These awards confirm the value of this revolutionary product.



## Height



| 4V | 5V | 6V

- | 4 Vertebrae cm 29
- | 5 Vertebrae cm 35
- | 6 Vertebrae cm 42

## Width



| S | M | L | XL |

- | **S** for wheelchairs from 28 to 35
- | **M** for wheelchairs from 35 to 40
- | **L** for wheelchairs from 38 to 43
- | **XL** for wheelchairs from 40 to 45

## Depth

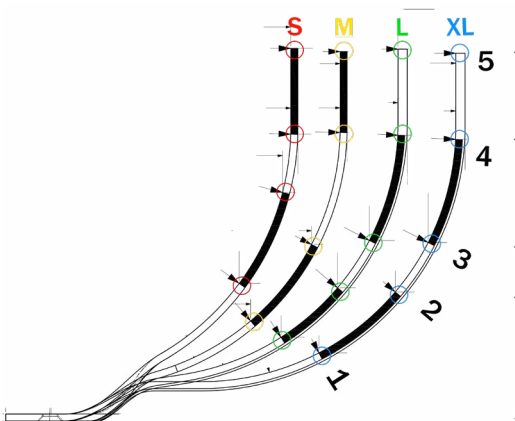

DOGA N°	1	2	3	4	5
<b>S</b>	55mm	93mm	117mm	153mm	/
<b>M</b>	40mm	73mm	122mm	156mm	/
<b>L</b>	33mm	55mm	75mm	120mm	158mm
<b>XL</b>	26mm	53mm	74mm	119mm	156mm







Aluminum is the most adaptable material to make each stave of the backrest suits the user's body!



STANDARD



CONTOUR

	STANDARD	CONTOUR
<p>4V S-M-L-XL</p>		
<p>5V S-M-L-XL</p>		
<p>6V S-M-L-XL</p>		

3 heights  
4 widths  
2 depths

**24 models**





# Adjustable clamp for rigid frame wheelchairs



## Characteristics:

- 1 height adjustment
- 2 rotation adjustment
- 3 depth adjustment
- 4 tube diameter: 19-22-25 mm

4



1

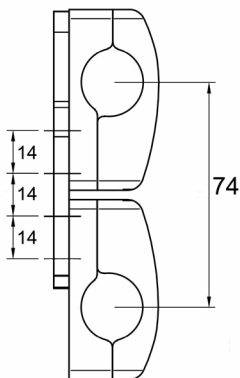

2

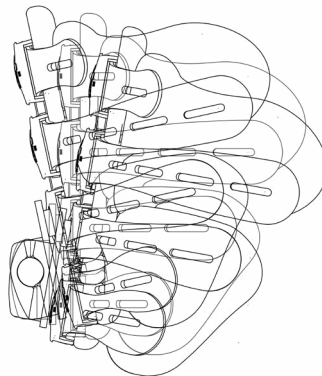

3

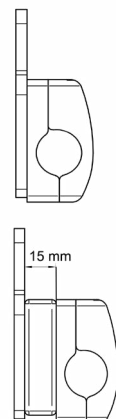





## Clamp for rigid wheelchairs



### Characteristics:

- ① rotation adjustment
- ② tube diameter: 20-25 mm

①

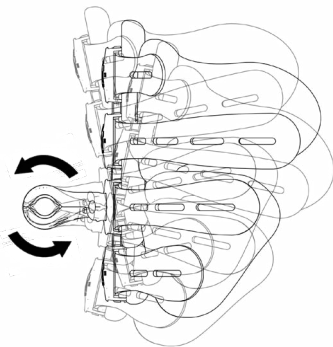

②

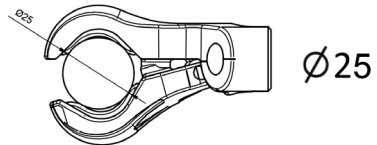
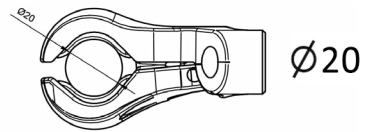

## Clamp for rigid wheelchairs - Type G -



### Characteristics:

- ① rotation adjustment
- ② tube diameter: 19-22 mm

①

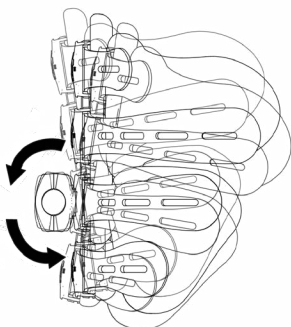

②

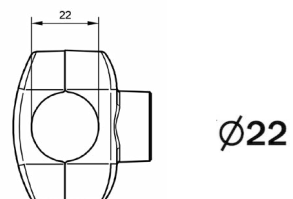
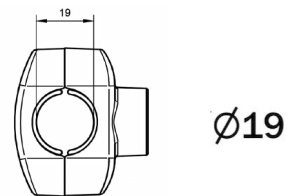



# Adjustable clamp for folding wheelchairs

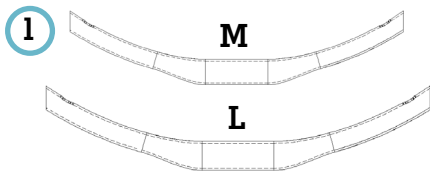

### Characteristics:

1 rigidizer bar to specify:

**M:** 36 - 41 cm    **L:** 41 - 46 cm

2 hose clamp: 19-21 / 22-25 mm

3 height adjustment

4 depth adjustment

5 rotation adjustment

6 easy unhook

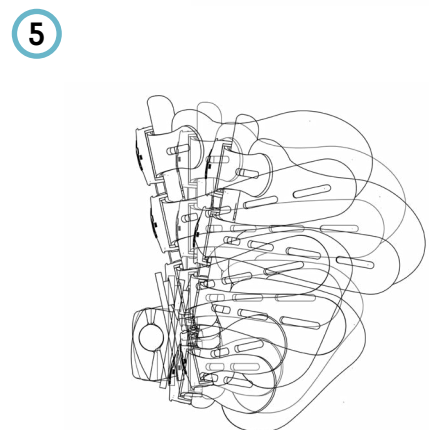
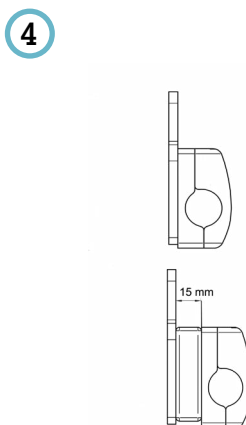
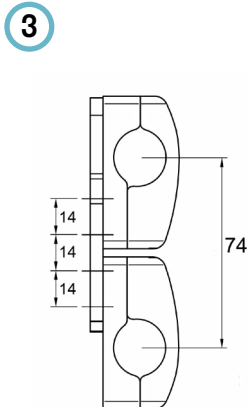
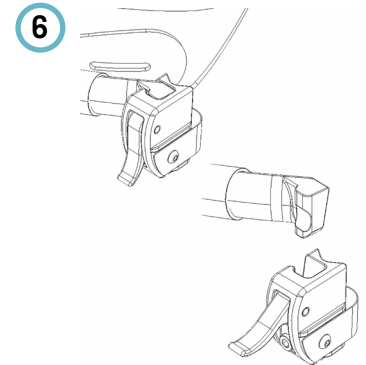
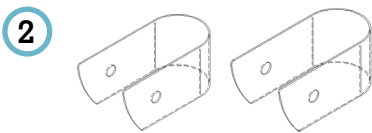



## Features (for more details check "The Guide")

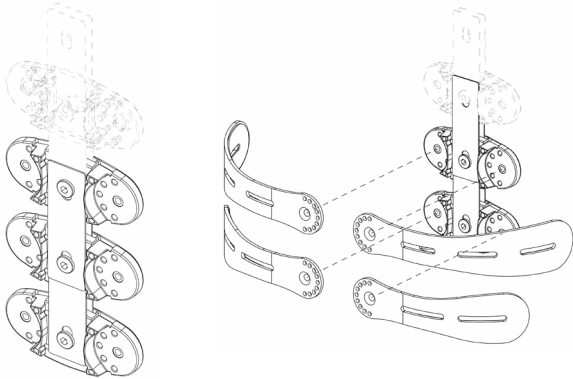

### Modular structure

to change easily the length of the backrest! This feature is extremely useful for children.

### Extreme customization

to satisfy all the user needs.

Every stave and every vertebrae can be inclined to follow also scoliosis cases.

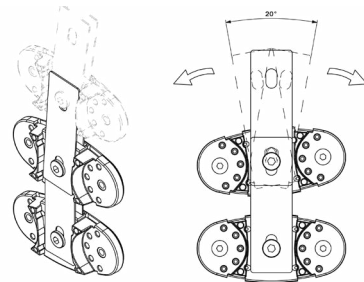
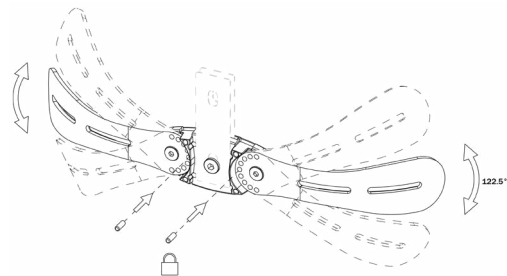

### Soft, breathable and fresh

feeling to maximize the comfort of the backrest.

The spaces between the pads helps to keep dry the back of the user.

Each pad is made of washable foam, realized with breathable technical material for maximal comfort.





Choose your **style.**



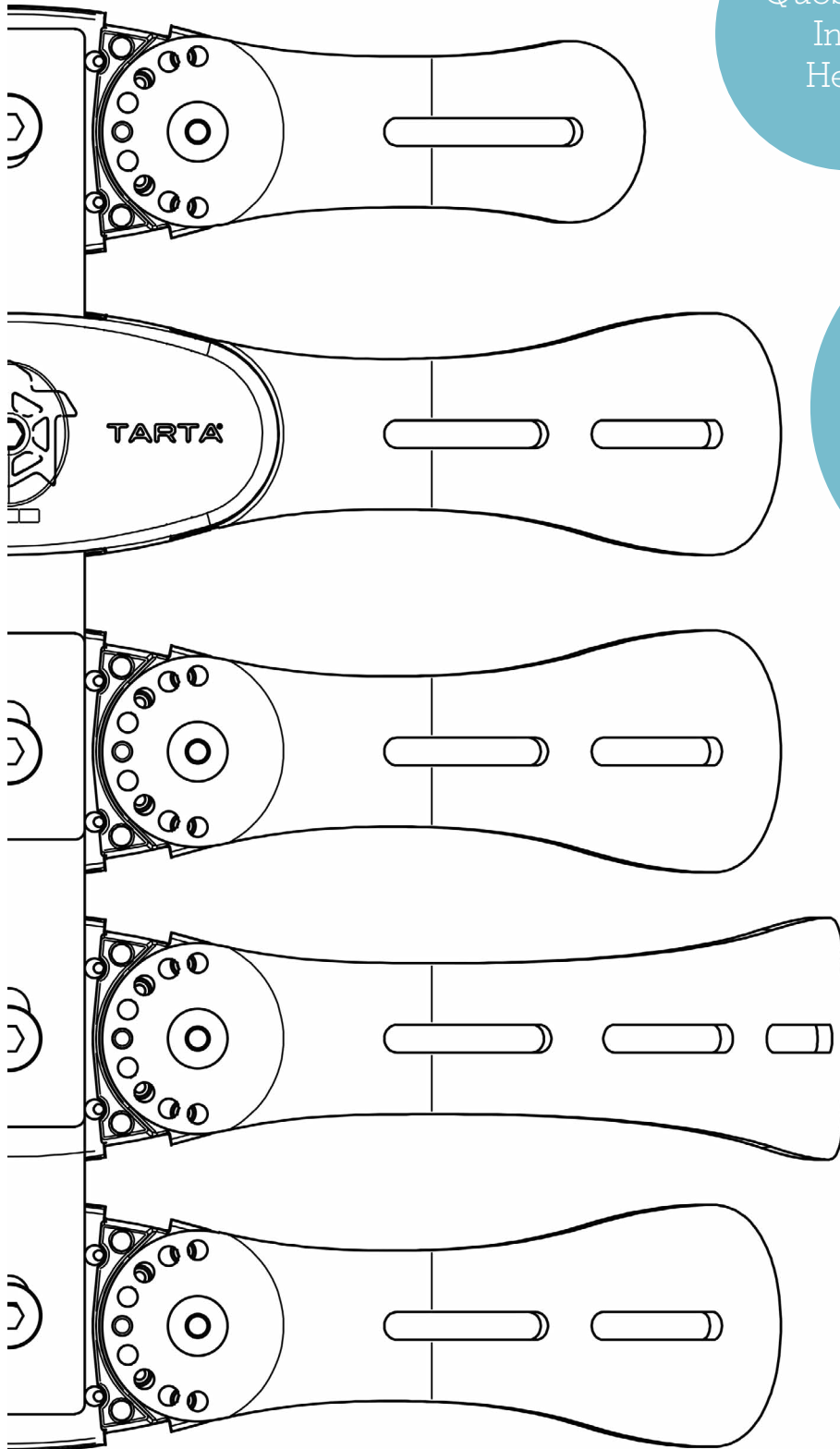

Questions?  
Info?  
Help?

Visit our website:  
[www.tartadesign.it](http://www.tartadesign.it)

or contact us at:  
[info@tartadesign.it](mailto:info@tartadesign.it)



### **Tarta Design srl**

Via Cottonificio, 56  
33037 Pasian di Prato  
Udine - Italy  
T +39 0432 722 533  
F +39 0432 542 920

[www.tartadesign.it](http://www.tartadesign.it)  
[info@tartadesign.it](mailto:info@tartadesign.it)



[www.mobilityplus.com.au](http://www.mobilityplus.com.au)  
13000 11000  
[info@mobilityplus.com.au](mailto:info@mobilityplus.com.au)